

M12 female 0° shielded B-cod. with cable, Profibus

PVC 1x2xAWG24 shielded vt UL/CSA 3m

PROFIBUS

Female straight

M12, 2-pole

B-coded

shielded

Plastic housings with good resistance against chemicals and oils.

The resistance to aggressive media should be individually tested for your application. Further details on request.

Further cable lengths on request.

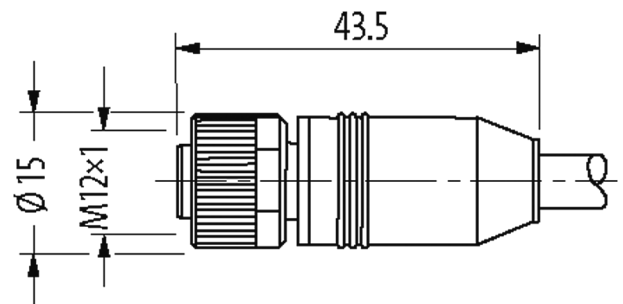
Illustration

Female



Product may differ from Image

Approvals

* only for products with UL/CSA approved cable

cCSAus

More Info

**Form**

Form 14061

CablesNo./diameter of wires 1 x 2 x 0.25 mm²

Wire isolation PE (rd, gn)

C-track properties 2 Mio.

Material (jacket) PVC (UL)

Outer Ø 7.8 mm ±5%

Bend radius (moving) 12 x outer Ø

Temperature range (fixed) -25...+70 °C

Temperature range (mobile) -20...+50 °C

Cable identification 850

Cable weight [g/m] 75,90

Material (wire) Cu wire, bare

Resistor (core) max. 68 Ω/km (20 °C)

Single wire Ø (core) 0.13 mm

Construction (core) 19 x 0.13 mm

Diameter (core) 1 x 2 x 0.25 mm²

AWG similar to AWG 24

Material (wire isolation) PE

Wire-Ø incl. isolation 2.55 mm ±5%

Color/numbering of wires rd, gn

Shield yes

min. 70%

Material (jacket) PVC

Outer-Ø (jacket) 7.8 mm ±5%

Color (jacket) violet

Nominal voltage 30 V AC

Test voltage 1.5 kV

Temperature range (fixed) -25...+70 °C

Temperature range (mobile) -20...+50 °C

Bend radius (fixed) 7.5 x outer Ø

Bend radius (moving) 12 x outer Ø

No. of bending cycles (C-track) max. 2 Mio. (25 °C)

Traversing distance (C-track) max. 5 m (horizontal)

Travel speed (C-track) max. 3 m/s

Acceleration (C-track) max. 5 m/s²

Jacket Color violet

Technical Data

Operating voltage max. 60 V AC/DC

Operating voltage (only UL listed) max. 30 V AC/DC

Rated surge voltage 1.5 kV

Operating current per contact max. 4 A

Material group IEC 60664-1, category I

Coding B-coded

Locking of ports Screw thread (M12x1 mm) recommended torque 0.6 Nm, self-securing

Compression gland	M12 (SW13)
Protection	IP65, IP66K, IP67 inserted and tightened (EN 60529)
Locking material	Zinc die casting, matte nickel plated
Material	PUR

General data

Standards	DIN EN 61076-2-101 (M12)
Pollution Degree	3
Stripping length (jacket)	20 mm
Temperature range	-25...+85 °C, depending on cable quality

Commercial data

country of origin	DE
customs tariff number	85444290
EAN	4048879461238
eClass	27061801
Packaging unit	1